

THIS IS AN ACAD DRAWING
DO NOT MAKE MANUAL CHANGES

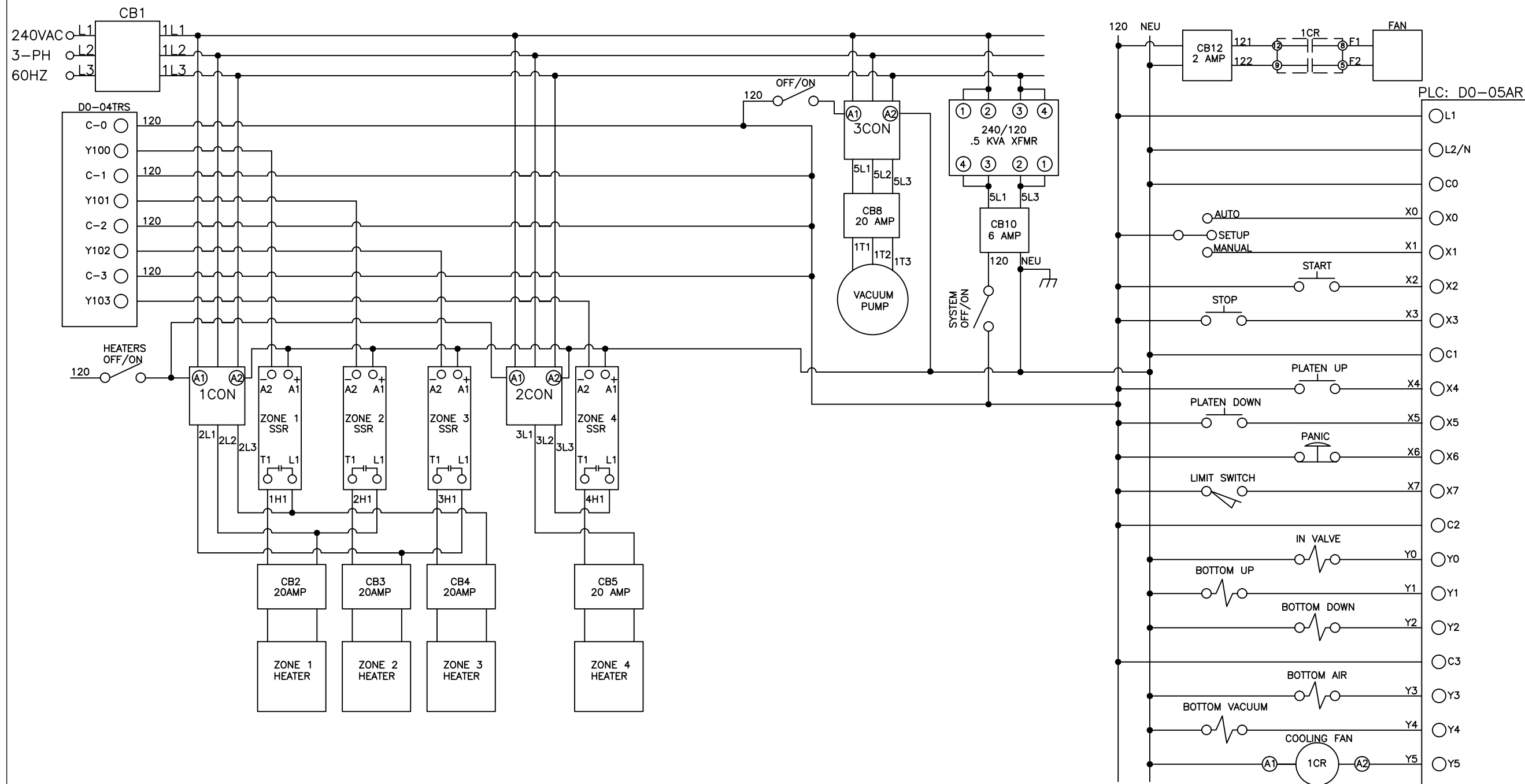

- CONFIDENTIAL - PROPERTY OF -		
SIBE Automation		
1521 SW 12th AVE St700 Ocala, Florida 34471		
SCALE : NONE	BOM :	DRAWN BY : GLE
DATE : 07-28-2012		CHECK BY :
B	4-ZONE CNTLR	SHEET 1 OF 6
TITLE : MAIN POWER		DRAWING NUMBER VF0004-1